

TRX4M

MODEL 97074-1



BRONCO



TRAXAS

OWNER'S MANUAL

INTRODUCTION

- 3 BEFORE YOU PROCEED
- 4 SAFETY PRECAUTIONS
- 7 TOOLS, SUPPLIES, AND REQUIRED EQUIPMENT
- 8 MODEL OVERVIEW
- 9 QUICK START: GETTING UP TO SPEED
- 10 TRAXXAS TQ RADIO SYSTEM
- 16 ECM-2.5 ELECTRONIC CONTROL MODULE
- 17 DRIVING YOUR MODEL
- 19 TUNING ADJUSTMENTS
- 21 MAINTAINING YOUR MODEL

Thank you for purchasing the Traxxas TRX-4M™ with the Ford Bronco Body. This officially licensed model gets the full Traxxas treatment with unsurpassed realism, including molded Bronco-embazoned grille, door handles, and side mirrors. The design of the TRX-4M offers a new way to experience all the fun, adventure, and scale realism of the TRX-4 in a 1/18 platform. Oil-filled shocks control body motion and provide smooth suspension travel over any terrain. Steel frame rails and a smooth running drivetrain give it true outdoor capability over rocks and through grass and streams. The tight turning radius and precise throttle control give it fantastic indoor maneuverability. Your new RC model offers the highest level of innovation, performance, and quality that is the hallmark of all Traxxas vehicles.

This manual contains the instructions you will need to operate and maintain your model so that you can enjoy it for years to come. We want you to feel confident that you own one of the best-performing models in the market and that it is backed by a team of professionals who aim to provide the highest level of factory support possible. Traxxas models are about experiencing total performance and satisfaction, not just with your model, but also with the company that stands behind it.

We know you're excited about getting your new model on the trail, but it's very important that you take some time to read through the Owner's Manual. This manual contains all the necessary setup and operating procedures that allow you to unlock the performance and potential that Traxxas engineers designed into your model.

FCC Compliance

This device contains a module that complies with the limits for a Class B digital device as described in part 15 of the FCC rules. Operation is subject to the following two conditions: (1) This device may not cause harmful interference, and (2) this device must accept any interference received, including interference that may cause undesired operation.

The limits for a Class B digital device are designed to provide reasonable protection against harmful interference in residential settings. This product generates, uses and can radiate radio frequency energy, and, if not operated in accordance with the instructions, may cause harmful interference to radio communications. The user is cautioned that changes or modifications not expressly approved by the party responsible for compliance could void the user's authority to operate the equipment.

Canada, Industry Canada (IC)

This Class B digital apparatus complies with Canadian ICES-003 and RSS-210. This device complies with Industry Canada license exempt RSS standard(s). Operation is subject to the following two conditions: This device may not cause interference, and This device must accept any interference, including interference that may cause undesired operation of the device.

Radio Frequency (RF) Exposure Statement

This equipment complies with radio frequency exposure limits set forth by FCC and Industry Canada for an uncontrolled environment. This equipment should be installed and operated with a minimum distance of 20 centimeters between the radiator and your body or bystanders and must not be co-located or operating in conjunction with any other antenna or transmitter.

Operation Frequency: 2406~2453 MHz

Maximum Radio Frequency Power: Maximum Peak Power -1 dBm

Traxxas Support

Traxxas support is with you every step of the way. Refer to the next page to find out how to contact us and what your support options are.



Quick Start

This manual is designed with a Quick Start path that outlines the necessary procedures to get your model up and running in the shortest time possible. If you are an experienced RC enthusiast, you will find it helpful and fast. Be sure and read through the rest of the manual to learn about important safety, maintenance, and adjustment procedures. Turn to page 10 to begin.



Even if you are an experienced RC enthusiast, it's important to read and follow the procedures in this manual.

Thank you again for going with Traxxas. We work hard every day to assure you the highest level of customer satisfaction possible. We truly want you to enjoy your new model!

REGISTERING YOUR MODEL

In order to serve you better as our customer, please register your product within 10 days of your purchase online at Traxxas.com/register.

Traxxas.com/register

BEFORE YOU PROCEED

Carefully read and follow all instructions in this and any accompanying materials to prevent serious damage to your model. Failure to follow these instructions will be considered abuse and/or neglect.

Before running your model, look over this entire manual and examine the model carefully. If for some reason you decide it is not what you wanted, then do not continue any further. **Your hobby dealer absolutely cannot accept a model for return or exchange after it has been run.**

Warnings, Helpful Hints, & Cross-References

Throughout this manual, you'll notice warnings and helpful hints identified by the icons below. Be sure to read them!

 An important warning about personal safety or avoiding damage to your model and related components.

 Special advice from Traxxas to make things easier and more fun.

 Refers you to a page with a related topic.

SUPPORT

If you have any questions about your model or its operation, call the Traxxas Technical Support Line toll-free at: **1-888-TRAXXAS (1-888-872-9927)***

Technical support is available 7 days a week from 8:30am to 9:00pm central time. Technical assistance is also available at Traxxas.com. You may also e-mail customer support with your question at support@Traxxas.com. Join thousands of registered members in our online community at Traxxas.com.

Traxxas offers a full-service, on-site repair facility to handle any of your Traxxas service needs. Maintenance and replacement parts may be purchased directly from Traxxas by phone or online at Traxxas.com. You can save time, along with shipping and handling costs, by purchasing replacement parts from your local dealer.

Do not hesitate to contact us with any of your product support needs. We want you to be thoroughly satisfied with your new model!

Traxxas
6250 Traxxas Way
McKinney, Texas 75070
Phone: 972-549-3000
Toll-free 1-888-TRAXXAS

Internet
Traxxas.com
E-mail: support@Traxxas.com

Entire contents ©2022 Traxxas. All rights reserved. Traxxas, Ready-To-Drive, TQ, Titan, TRX-4M, and ECM-2.5 are trademarks or registered trademarks of Traxxas. Other brand names and marks are the property of their respective holders and are used only for purposes of identification. No part of this manual may be reproduced or distributed in print or electronic media without the express written permission of Traxxas. Specifications are subject to change without notice.



Ford Motor Company Trademarks and Trade Dress used under license to Traxxas.

Ford® and Bronco® are trademarks of Ford Motor Company. All copyrights and trademarks are used by Traxxas under license.

*Toll-free support is available to U.S. residents only.

SAFETY PRECAUTIONS



All instructions and precautions outlined in this manual should be strictly followed to ensure safe operation of your model.



This model is not intended for use by children under 18 years of age without the supervision of a responsible and knowledgeable adult.



No previous experience with radio controlled models is required. Models require a minimum of setup, maintenance, or support equipment.

All of us at Traxxas want you to safely enjoy your new model. Operate your model sensibly and with care, and it will be exciting, safe, and fun for you and those around you. Failure to operate your model in a safe and responsible manner may result in property damage and serious injury. The precautions outlined in this manual should be strictly followed to help ensure safe operation. You alone must see that the instructions are followed and the precautions are adhered to.

Important Points to Remember

- Your model is not intended for use on public roads or congested areas where its operation can conflict with or disrupt pedestrian or vehicular traffic.
- Never, under any circumstances, operate the model in crowds of people. Your model may present a tripping hazard and could cause injury.
- Because your model is controlled by radio, it is subject to radio interference from many sources that are beyond your control. Since radio interference can cause momentary losses of radio control, always allow a safety margin in all directions around the model in order to prevent collisions.
- The motor can become hot during use. Be careful to avoid getting burned.
- Don't operate your model at night, or anytime your line of sight to the model may be obstructed or impaired in any way.

Electronic Control Module (ECM)

Your model's electronic control module (ECM) is an extremely powerful electronic device capable of delivering high current. Please closely follow these precautions to prevent damage to the ECM or other components.

- **Disconnect the Battery:** Always disconnect the battery from the ECM when not in use.
- **Insulate the Wires:** Always insulate exposed wiring with heat shrink tubing to prevent short circuits.
- **Transmitter on First:** Switch on your transmitter first before connecting the battery to the ECM. Disconnect the battery before turning off the transmitter.
- **Don't Get Burned:** The motor can become extremely hot during use, so be careful not to touch it until it cools. Supply adequate airflow for cooling.
- **Use the Factory-Installed Connectors:** Do not change the battery or motor connectors. Improper wiring can cause fire or damage to the ECM. Please note that modifying the electrical components will void your warranty.
- **No Reverse Voltage:** The ECM is not protected against reverse polarity voltage.
- **Always adhere to the minimum and maximum limitations of the ECM.** Only use the ECM with the included Traxxas 2-cell LiPo iD® battery and a compatible Traxxas motor.





WARNING! CAUTION! DANGER!

FIRE HAZARD! This vehicle requires LiPo batteries. Charging and discharging batteries has the potential for fire, explosion, serious injury, and property damage if not performed per the instructions. In addition, Lithium Polymer (LiPo) batteries pose a SEVERE risk of fire if not properly handled per the instructions and require special care and handling procedures for long life and safe operation. LiPo batteries are intended only for advanced users that are educated on the risks associated with LiPo battery use. Traxxas does not recommend that anyone under the age of 18 use or handle LiPo battery packs without the supervision of a knowledgeable and responsible adult. DO NOT attempt to charge or use LiPo batteries if you do not understand these warnings. Dispose of used batteries according to the instructions.

- Your model requires the use of LiPo batteries. LiPo batteries have a minimum safe discharge voltage threshold that should not be exceeded. The electronic control module (ECM) is equipped with built-in Low-Voltage Detection that alerts the driver when LiPo batteries have reached their minimum voltage (discharge) threshold. It is the driver's responsibility to stop immediately to prevent the battery pack from being discharged below its safe minimum threshold.
- Low-Voltage Detection is just one part of a comprehensive plan for safe LiPo battery use. It is critical to follow all instructions for safe and proper charging, use, and storage of LiPo batteries. Make sure you understand how to use your LiPo batteries. If you have questions about LiPo battery usage, please consult with your local hobby dealer or contact the battery manufacturer. As a reminder, all batteries should be recycled at the end of their useful life.
- ONLY use the supplied Traxxas iD® LiPo balance charger to charge the included Traxxas iD battery. Never use NiMH or NiCad-type chargers or charge modes to charge LiPo batteries. DO NOT charge LiPo batteries with a NiMH-only charger. The use of a NiMH or NiCad charger or charge mode will damage LiPo batteries and may cause fire, personal injury, and/or property damage.
- NEVER charge LiPo battery packs in series or parallel. Charging packs in series or parallel may result in improper charger cell recognition and an improper charging rate that may lead to overcharging, cell imbalance, cell damage, and fire.



- ALWAYS inspect your LiPo batteries carefully before charging. Look for any loose leads or connectors, damaged wire insulation, damaged cell packaging, impact damage, fluid leaks, swelling (a sign of internal damage), cell deformity, missing labels, or any other damage or irregularity. If any of these conditions are observed, do not charge or use the battery pack. Follow the disposal instructions included with your battery to properly and safely dispose of the battery.
- DO NOT store or charge LiPo batteries with or around other batteries or battery packs of any type, including other LiPos.
- Store and transport your battery pack(s) in a cool dry place. DO NOT store in direct sunlight. DO NOT allow the storage temperature to exceed 140°F or 60°C, such as in the trunk of a car, or the cells may be damaged and create a fire risk.
- DO NOT disassemble LiPo batteries or cells.
- DO NOT attempt to build your own LiPo battery pack from loose cells.
- BEFORE you charge, ALWAYS confirm that the charger settings exactly match the type (chemistry), specification, and configuration of the battery to be charged. DO NOT exceed the maximum manufacturer recommended charge rate.
- DO NOT attempt to charge non-rechargeable batteries (explosion hazard), batteries that have an internal charge circuit or a protection circuit, batteries that have been altered from original manufacturer configuration, or batteries that have missing or unreadable labels, preventing you from properly identifying the battery type and specifications. ALWAYS use a Traxxas iD charger to charge Traxxas iD batteries. DO NOT use a non-Traxxas charger to charge Traxxas iD batteries. It is not recommended, but if you choose to use a non-Traxxas charger or battery, read and follow all of the manufacturer's warnings and instructions.
- DO NOT let any exposed battery contacts or wires touch each other. This will cause the battery to short circuit and create the risk of fire.
- While charging or discharging, ALWAYS place the battery (all types of batteries) in a fire retardant/fire proof container and on a non-flammable surface such as concrete.
- DO NOT charge batteries inside of an automobile. DO NOT charge batteries while driving in an automobile.
- NEVER charge batteries on wood, cloth, carpet, or on any other flammable material.

(continued from previous page)

- ALWAYS charge batteries in a well-ventilated area.
- REMOVE flammable items and combustible materials from the charging area.
- DO NOT leave the charger and battery unattended while charging, discharging, or anytime the charger is ON with a battery connected. If there are any signs of a malfunction or in the event of an emergency, unplug the charger from the power source and disconnect the battery from the charger.
- DO NOT operate the charger in a cluttered space, or place objects on top of the charger or battery.
- If any battery or battery cell is damaged in any way, DO NOT charge, discharge, or use the battery.
- Keep a Class D fire extinguisher nearby in case of fire.
- DO NOT disassemble, crush, short circuit, or expose the batteries to flame or other source of ignition. Toxic materials could be released. If eye or skin contact occurs, flush with water.
- If a battery gets hot to the touch during the charging process (temperature greater than 110°F / 43°C), immediately disconnect the battery from the charger and discontinue charging.
- Allow the battery pack to cool off between runs (before charging).
- ALWAYS unplug the charger and disconnect the battery when not in use.
- ALWAYS unplug the battery from the electronic control module (ECM) when the model is not in use and when it is being stored or transported.
- DO NOT disassemble the charger.
- REMOVE the battery from your model or device before charging.
- DO NOT expose the charger to water or moisture. For indoor use only.
- DO NOT use an adapter of any kind or modify or change the battery plug/connector.
- ALWAYS store battery packs safely out of the reach of children or pets. Children should always have adult supervision when charging and handling batteries.
- Always proceed with caution and use good common sense at all times.

TOOLS, SUPPLIES, AND REQUIRED EQUIPMENT

Your model comes with a set of specialty metric tools. You'll need to purchase other items, available from your hobby dealer, to operate and maintain your model.

Supplied Tools and Equipment



2.0mm "L" wrench



1.5mm "L" wrench



4-way wrench



Shock pre-load spacers



750mAh 7.4V 2-cell iD[®] LiPo battery*



iD[®] LiPo balance charger*

Traxxas recommends genuine Traxxas iD[®] batteries and chargers for safer charging, maximum battery life, and performance.

Required Equipment (not included)



4 AA alkaline batteries



For more information on batteries, see *Use the Right Batteries* on page 13.



Recommended Equipment
These items are not required for the operation of your model, but are a good idea to include in any R/C toolbox:

- Safety glasses
- Hobby knife
- Side cutters and/or needle nose pliers
- Speed Bit Set, Part #8712

*Battery and charger style are subject to change and may vary from images.

MODEL OVERVIEW

Chassis Top View

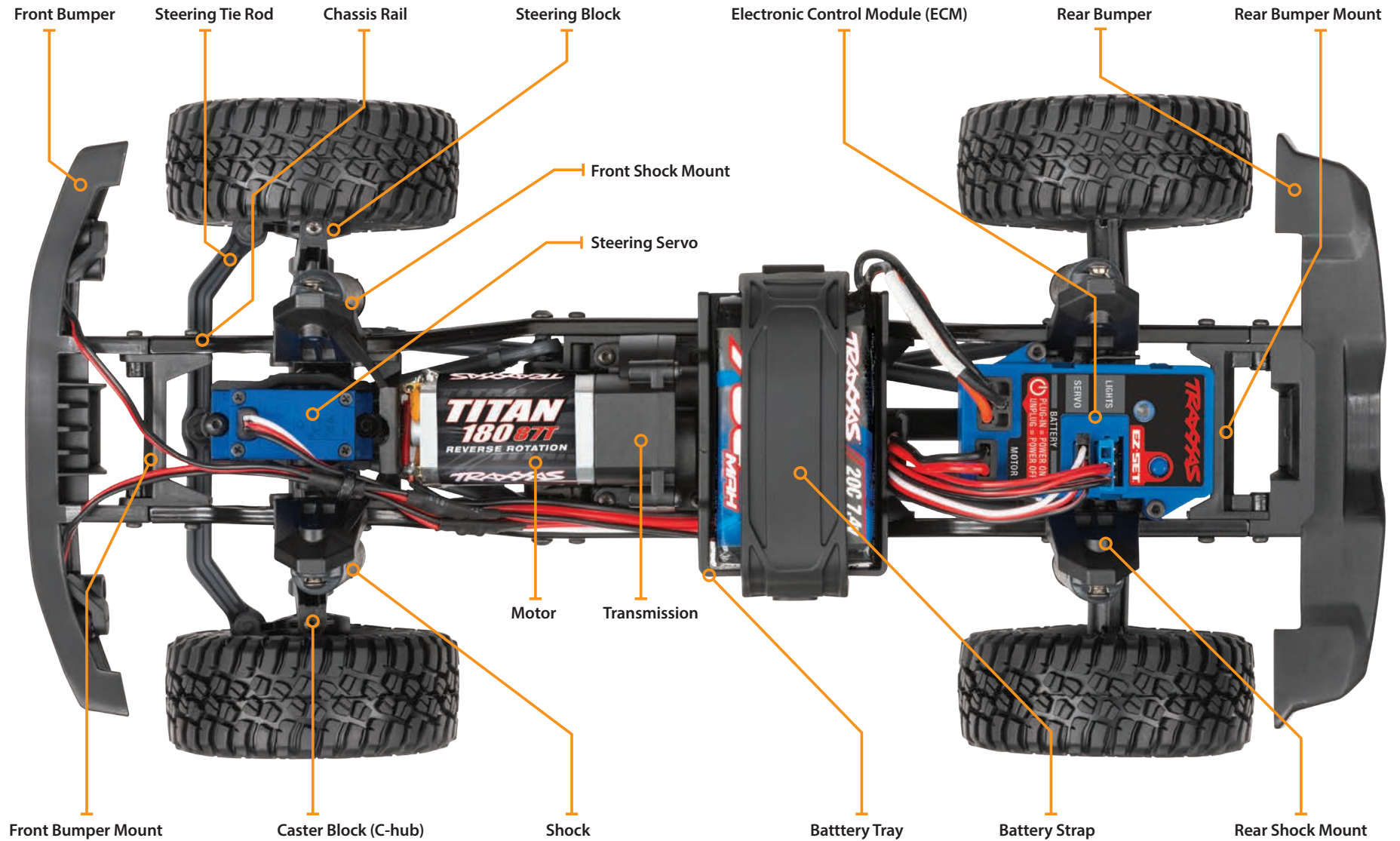

Chassis Bottom View

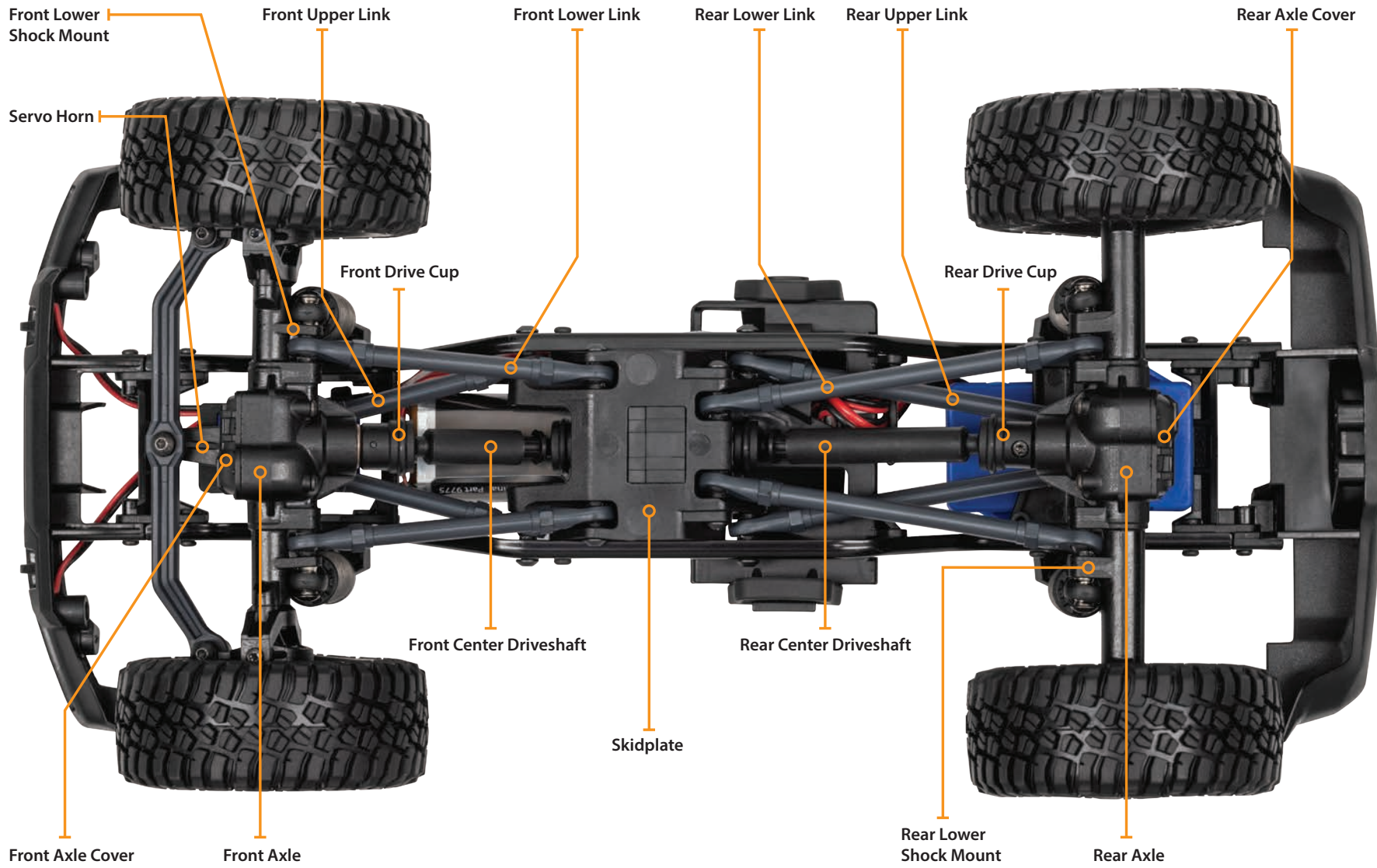

QUICK START: GETTING UP TO SPEED



The Quick Start Guide is not intended to replace the full operating instructions available in this manual. Please read this entire manual for complete instructions on the proper use and maintenance of your model.

Look for the Quick Start logo at the bottom of Quick Start pages.



The following guide is an overview of the procedures for getting your model running. Look for the Quick Start logo on the bottom corners of Quick Start pages.



1. Read the safety precautions on page 4

For your own safety, understand where carelessness and misuse could lead to personal injury.



5. Turn on the radio system • See page 15

Make a habit of turning the transmitter on first and off last.



2. Charge the battery pack • See page 13

Fully charge the battery pack included with your model.



6. Drive your model • See page 18

Driving tips and adjustments for your model.



3. Install batteries in the transmitter • See page 13

The transmitter requires 4 AA alkaline batteries (sold separately).



7. Maintaining your model • See page 22

Follow these critical steps to maintain the performance of your model and keep it in excellent running condition.



4. Install the battery pack • See page 14

Install the included battery pack in your model.

INTRODUCTION

Your model includes the TQ 2.4GHz transmitter. When powered on, the TQ 2.4GHz will automatically locate and lock onto an available frequency, allowing multiple models to be raced together without frequency conflicts. Just switch on and drive! The included TQ 2.4GHz radio system has been programmed for your model at the factory and does not require adjustment, but it does have settings you may need to access to maintain proper operation of your model. The detailed instructions (page 15) included in this manual will help you understand and operate the functions of the new TQ 2.4GHz radio system. For additional information and how-to videos, visit Traxxas.com.

RADIO AND POWER SYSTEM TERMINOLOGY

Please take a moment to familiarize yourself with these radio and power system terms. They will be used throughout this manual.

2.4GHz Spread Spectrum – This model is equipped with the latest R/C technology. Unlike AM and FM systems that require frequency crystals and are prone to frequency conflicts, the TQ 2.4GHz system automatically selects and locks onto an open frequency, offering superior resistance to interference and “glitching.”

BEC (Battery Eliminator Circuit) - The BEC can either be in the receiver or in the ESC. This circuit allows the receiver and servos to be powered by the main battery pack in an electric model. This eliminates the need to carry a separate pack of 4 AA batteries to power the radio equipment.

Current - Current is a measure of power flow through the electronics, usually measured in amps. If you look at wire like a garden hose, current is a measure of how much water is flowing through the hose.

ESC (Electronic Speed Control) - An electronic speed control is the electronic motor control inside the model. Electronic speed controls use power more efficiently than mechanical speed controls so that the battery runs longer. An electronic speed control also has circuitry that prevents loss of steering and throttle control as the battery loses its charge. For the TRX-4M, the ESC is built into the ECM-2.5 electronic control module.

ECM (Electronic Control Module) - An all-in-one module that incorporates both an electronic speed control and a radio receiver into one electronic device.

Frequency band - The radio frequency used by the transmitter to send signals to your model. This model operates on the 2.4GHz direct-sequence spread spectrum.

LiPo - Abbreviation for Lithium Polymer. Rechargeable LiPo battery packs are known for their special chemistry, which allows extremely high energy density and current handling in a compact size. These are high-performance batteries that require special care and handling. For advanced users only.

mAh – Abbreviation for milliamp hour, a measure of the capacity of the battery pack. The higher the number, the longer the battery will last between recharges.

Neutral position - The standing position that the servos seek when the transmitter controls are at the neutral setting.

NiCad - Abbreviation for nickel-cadmium. The original rechargeable hobby pack, NiCad batteries have very high current handling, high capacity, and can last up to 1000 charging cycles. Good charging procedures are required to reduce the possibility of developing a “memory” effect and shortened run times.

NiMH - Abbreviation for nickel-metal hydride. Rechargeable NiMH batteries offer high current handling and much greater resistance to the “memory” effect. NiMH batteries generally allow higher capacity than NiCad batteries. They can last up to 500 charge cycles. A peak charger designed for NiMH batteries is required for optimal performance.

Receiver - The radio unit inside your model that receives signals from the transmitter and relays them to the servos.

Resistance - In an electrical sense, resistance is a measure of how an object resists or obstructs the flow of current through it. When flow is constricted, energy is converted to heat and is lost. Traxxas power systems are optimized to reduce electrical resistance and the resulting power-robbing heat.

Servo - Small motor unit in your model that operates the steering mechanism.

Transmitter - The hand-held radio unit that sends throttle and steering instructions to your model.

Trim - The fine-tuning adjustment of the neutral position of the servos, made by adjusting the steering trim knob on the face of the transmitter.

2-channel radio system - The TQ 2.4GHz radio system, consisting of the receiver, the transmitter, and the servos. The system uses two channels: one to operate the throttle and one to operate the steering.

Voltage - Voltage is a measure of the electrical potential difference between two points, such as between the positive battery terminal and ground. Using the analogy of the garden hose, while current is the quantity of water flow in the hose, voltage corresponds to the pressure that is forcing the water through the hose.

ECM-2.5 Wiring Diagram

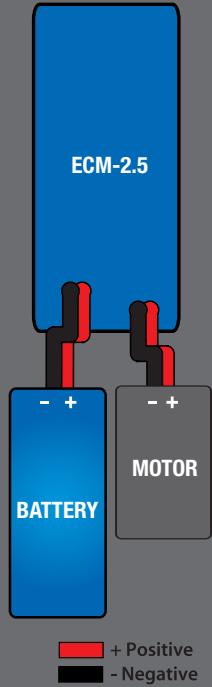

Your model is equipped with the Traxxas TQ 2.4GHz transmitter. The transmitter has two channels: channel one operates the steering, and channel two operates the throttle. Your model is equipped with one servo and an all-in-one electronic control module (speed control and receiver).

TRANSMITTER AND RECEIVER



MODEL WIRING DIAGRAM

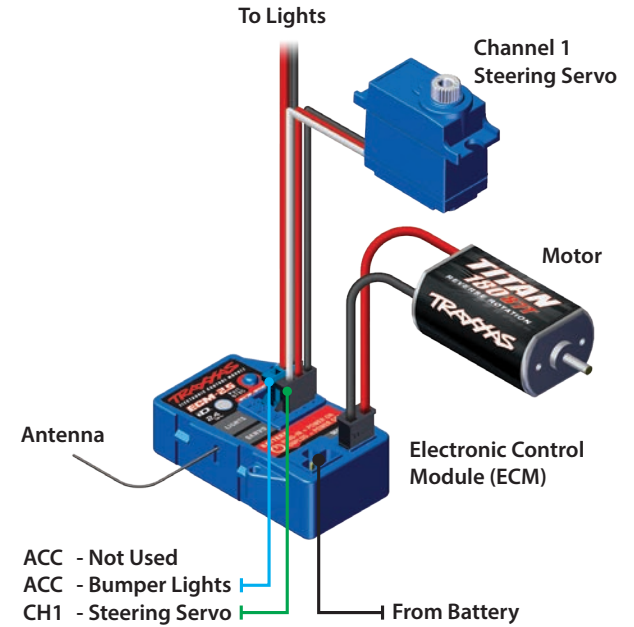

ECM-2.5 ELECTRONIC CONTROL MODULE

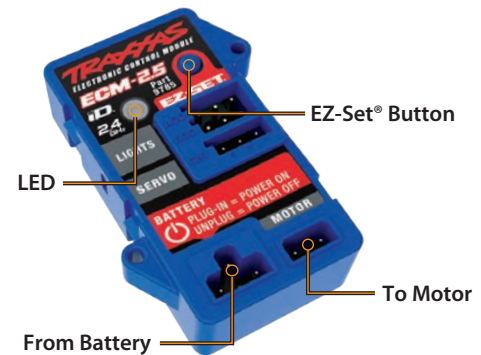



WARNING: FIRE HAZARD!

Users of Lithium Polymer (LiPo) batteries must read the Warnings and Precautions beginning on page 4. **ONLY** use the supplied Traxxas iD® LiPo balance charger to charge the included Traxxas iD® battery. **DO NOT** charge LiPo batteries with a NiMH-only charger. The use of a NiMH or NiCad charger or charge mode will damage LiPo batteries and may cause fire, personal injury, and/or property damage.

CHARGING THE BATTERY PACK

The supplied Traxxas iD® charger is a fully featured high-output LiPo balance charger. It features Traxxas iD technology to deliver the perfect charge with no guesswork. The charger is equipped with a universal USB-A plug for convenient charging almost anywhere.

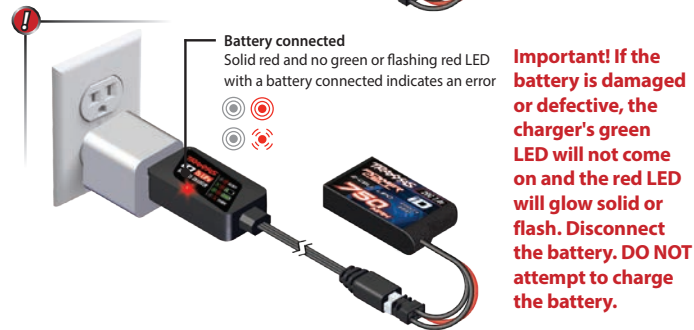
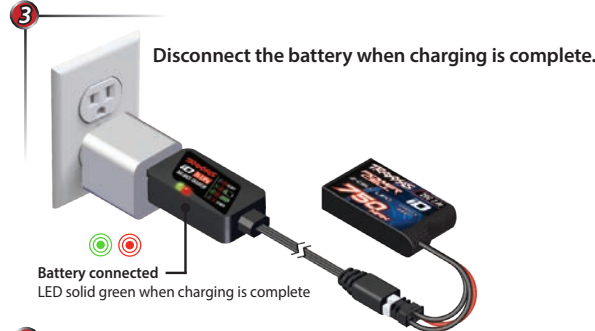
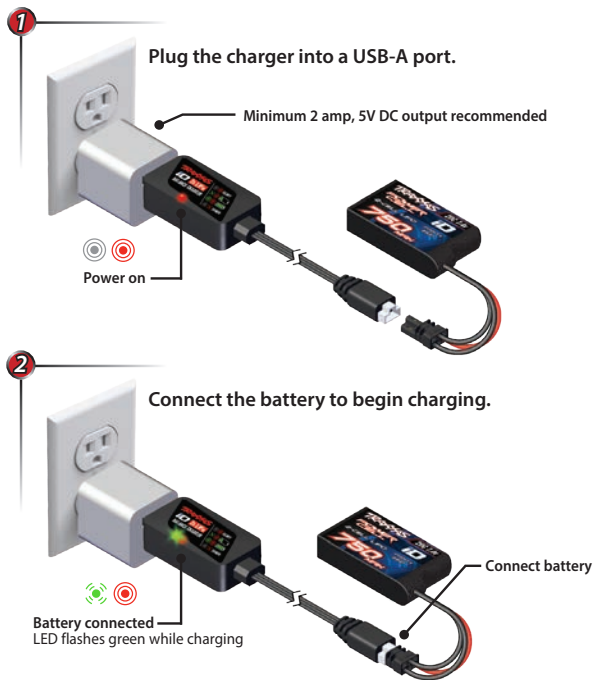

INSTALLING TRANSMITTER BATTERIES

Your TQ 2.4GHz transmitter uses 4 AA batteries. The battery compartment is located in the base of the transmitter.

1. Remove the battery compartment door by pressing the tab and sliding the door open.
2. Install the batteries in the correct orientation as indicated in the battery compartment.

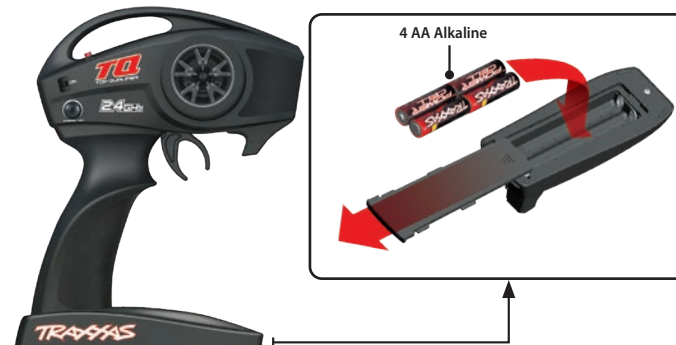

The supplied charger is designed for use only with the included Traxxas 2-cell LiPo iD battery. **DO NOT** attempt to charge other LiPo batteries or any other type of battery with this charger.



If the status LED doesn't light green on the transmitter, check the polarity of the batteries. Check rechargeable batteries for a full charge. If you see any other flashing signal from the LED, refer to the chart on page 17 to identify the code.



Use the Right Batteries

Your transmitter uses AA batteries. Use new alkaline batteries or rechargeable batteries, such as NiMH (nickel-metal hydride) batteries, in your transmitter. Make sure rechargeable batteries are fully charged according to the manufacturer's instructions.

If you use rechargeable batteries in your transmitter, be aware that when they begin to lose their charge, they lose power more quickly than regular alkaline batteries.

Caution: Discontinue running your model at the first sign of weak batteries (flashing red light) to avoid losing control.

3. Reinstall the battery compartment door and snap it closed.
4. Turn on the transmitter and check the status LED for a solid green light.



If the status LED flashes red, the transmitter batteries may be weak, discharged, or possibly installed incorrectly. Replace with new or freshly charged batteries. The status LED does not indicate the charge level of the battery pack installed in the model. Refer to the Troubleshooting section on page 16 for more information on the transmitter status LED codes.

REMOVING THE BODY

Your TRX-4M includes an innovative latching system (patent pending) for securing the body to the chassis (body clips are not required).

1. Reach beneath the front and rear bumpers and pull the latches outward to release them.
2. Push up on the latches to release the body.
3. Lift the body straight up from the chassis.



To reinstall the body:

1. Position the body on the chassis. Align the front and rear of the body with the front and rear bumpers.
2. Press down on the body above the latches until the latches snap into place.

INSTALLING THE BATTERY PACK

Your model includes a 750mAh 7.4V 2-cell iD[®] LiPo battery. Follow these steps to install the battery:

1. Unhook the battery strap from the tab on the battery tray.
2. Insert a fully charged battery into the battery tray with the battery wires positioned as shown.
3. Secure the battery in the tray by pulling the strap and stretching the end back over the tab.

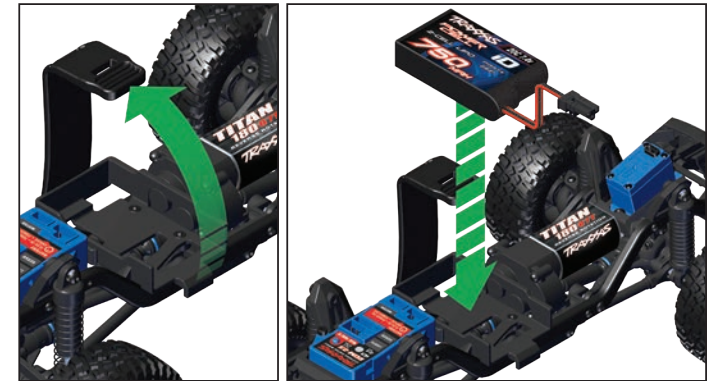

RADIO SYSTEM CONTROLS



i For maximum radio range, hold the transmitter upright and pointed in the direction of the model.

i Reversing: After stopping the model, return the transmitter's trigger to neutral and push up again to activate reverse throttle.



RADIO SYSTEM RULES

- Always turn your transmitter on first and off last. This procedure will help to prevent your model from receiving stray signals from another transmitter or other source.
- Always turn on the transmitter before plugging the battery into the ECM to turn on the model. **To turn the model off:** Unplug the battery from the ECM. **The battery should always be unplugged from the ECM when the vehicle is not in use.** For this reason, the model is not equipped with a traditional on/off switch.



Always turn your transmitter on first.

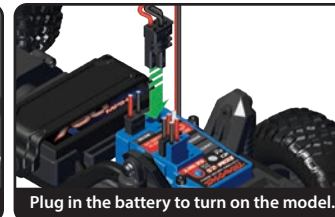

Plug in the battery to turn on the model.

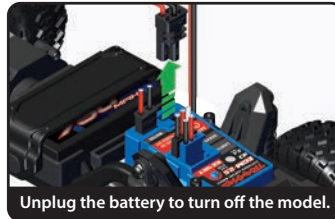

Unplug the battery to turn off the model.



Always turn your transmitter off last.

- Always use new or freshly charged batteries for the radio system. Weak batteries will limit the radio signal between the ECM and the transmitter.
- In order for the transmitter and ECM to bind to one another, the battery must be plugged into the ECM within 20 seconds of turning on the transmitter. The transmitter LED will flash fast red, indicating a failure to link. If you miss it, simply turn off the transmitter and start over.

RADIO SYSTEM BASIC ADJUSTMENTS

Steering Trim

To adjust, drive the vehicle forward slowly while "steering" with the trim knob until the vehicle travels in a straight line with no steering input.



TQ 2.4GHz Binding Instructions

For proper operation, the transmitter and ECM must be electronically 'bound.' **This has been done for you at the factory.** Should you ever need to re-bind the system or bind to a different transmitter or ECM, follow these instructions. **Note:** The transmitter and ECM must be within 5 feet of each other.

1. Press and hold the SET button on the transmitter.
2. Turn on the transmitter and release the SET button. The status LED will flash red slowly, indicating that the transmitter is in bind mode.
3. Press and hold the EZ-Set button on the ECM as you plug in the battery; release the EZ-Set button once the status LED flashes red.
4. The status LED will flash red slowly, indicating that the ECM is in bind mode.
5. When the LEDs on both the transmitter and the ECM turn solid green, the system is bound and ready for use. Confirm that the steering and throttle operate properly before driving your model.

TRANSMITTER LED CODES

| LED Color / Pattern | Name | Notes |
|---|----------------------|---|
| Solid green | Normal Driving Mode | See previous page for information on how to use the transmitter controls. |
| Slow red (0.5 sec on / 0.5 sec off) | Binding | See this page for more information on binding. |
| Flashing medium red (0.25 sec on / 0.25 sec off) | Low Battery Alarm | Put new batteries in the transmitter. See page 13 for more information. |
| Flashing fast red (0.125 sec on / 0.125 sec off) | Link Failure / Error | Transmitter and ECM are no longer bound. Unplug the battery to turn the system off. Plug the battery back in to resume normal operation. Find source of the link failure (i.e., out of range, low batteries). |

ECM LED CODES

| LED Color / Pattern | Name | Notes |
|---|-------------------------------|--|
| Solid green | Normal Driving Mode | See previous page for information on how to use your transmitter controls. |
| Slow red (0.5 sec on / 0.5 sec off) | Binding | See this page for more information on binding. |
| Blinking fast red (0.125 sec on / 0.125 sec off) | Failsafe / Low-Voltage Detect | Transmitter is off or vehicle battery needs to be recharged. |

ECM-2.5 ELECTRONIC CONTROL MODULE

PROFILE SELECTION

The ECM-2.5 electronic control module is factory set to Trail Mode (100% forward, brakes, and reverse; added brake drag when the throttle trigger is at neutral). To activate full power without the additional brake drag (Sport Mode) or set immediate reverse (Crawl Mode), follow these steps. The profiles are selected by entering the programming mode.

Profile Description

Profile #1 (Sport Mode): 100% Forward, 100% Brakes, 100% Reverse

Profile #2 (Trail Mode): 100% Forward, 100% Brakes, 100% Reverse, Drag Brake at Neutral

Profile #3 (Crawl Mode): 100% Forward, Hill Hold Brakes at Neutral, Immediate Reverse

Selecting Sport Mode

(Profile #1: 100% Forward, 100% Brakes, 100% Reverse)

1. Connect a fully charged battery to the ECM-2.5 and turn on your transmitter. The LED will glow solid green.
2. Press and hold the EZ-Set® button until the LED begins blinking red (indicating the Profile numbers).
3. When the LED blinks red once, release the EZ-Set button.
4. The LED will then turn solid green. The model is ready to drive.



Selecting Trail Mode

(Profile #2: 100% Forward, 100% Brakes, 100% Reverse, Drag Brake at Neutral)

1. Connect a fully charged battery to the ECM-2.5 and turn on your transmitter. The LED will glow solid green.
2. Press and hold the EZ-Set® button until the LED begins blinking red (indicating the Profile numbers).
3. When the LED blinks red twice, release the EZ-Set button.
4. The LED will then turn solid green. The model is ready to drive.



Selecting Crawl Mode

(Profile #3: 100% Forward, Hill Hold Brakes at Neutral, Immediate Reverse)

1. Connect a fully charged battery to the ECM-2.5 and turn on your transmitter. The LED will glow solid green.
2. Press and hold the EZ-Set® button until the LED begins blinking red (indicating the Profile numbers).
3. When the LED blinks red three times, release the EZ-Set button.
4. The LED will then turn solid green. The model is ready to drive.



Note: If you missed the mode you wanted, keep the EZ-Set button pressed down and the blink cycle will repeat until the button is released and a mode is selected.

LOW VOLTAGE DETECTION

The ECM is equipped with three-stage Low Voltage Detection (LVD) that alerts the driver when LiPo batteries have reached their minimum voltage (discharge) threshold. Stop immediately to prevent the battery pack from being discharged below its safe minimum threshold. Unplug the battery and recharge. Leaving the battery connected to the vehicle when not in use can cause permanent battery damage. **Always unplug the battery after use.**

| LOW VOLTAGE DETECTION | | | | | |
|-----------------------|-------------------|-----|--------|------------------------------|---------------------------------|
| STAGE | ECM LED | ECM | LIGHTS | EXPLANATION | ACTION |
| 1 | Slow blinking red | On | On | Vehicle speed reduced to 25% | Unplug the battery and recharge |
| 2 | Fast blinking red | On | On | Vehicle will not drive | Unplug the battery and recharge |
| 3 | Off | Off | Off | Stage 3 shutdown | Unplug the battery and recharge |

PRO SCALE® LIGHTING

Your new Traxxas model is enabled with Pro Scale® lighting features, such as headlights, reverse lights, and brake lights. Visit Traxxas.com to learn more about these features and available Traxxas Pro Scale Lighting Kits, parts, and accessories.

ECM-2.5 Specifications

Input Voltage
2s LiPo

Case Size
1.26" W x 1.79" L x 0.60" H

Weight
0.92 ounces / 26 grams

BEC Voltage
6.0 V DC

BEC Current
1A

Low-Voltage Detection
Yes / 3-stage

Transistor Type
MOSFET

Motor Overload Protection
2-stage

DRIVING YOUR MODEL

Now it's time to have some fun! This section contains instructions on driving and getting the most enjoyment out of your model. Before you go on, here are some important precautions to keep in mind:

- Your model is designed to run for long periods of mixed driving across different surface types. If you are running frequently in tall grass, deep sand, thick carpet, or other high load conditions, you may overheat the motor. Monitor the motor temperature and allow the model to cool if the motor becomes hot to the touch.
- The ECM-2.5 is equipped with Low Voltage Detection to prevent the LiPo battery from being discharged below its safe minimum threshold (see page 16 for more information). When this happens, stop driving immediately, unplug the battery, and recharge.
- When the batteries in the transmitter become weak, the red power light on the transmitter will begin to flash. Stop immediately and install new batteries.
- Do not drive the model on public streets or in large crowds of people. Your model may present a tripping hazard and could cause injury.
- Do not operate your model at night, or anytime your line of sight to the model may be obstructed or impaired in any way.
- If the model becomes stuck against an object, do not continue to run the motor. Remove the obstruction before continuing. Do not push or pull objects with the model.
- TRX-4M uses a sophisticated 4-link suspension to crawl over obstacles. If an obstacle is too large for your model to clear on the first attempt, back up and consider a different angle or approach. Even a slight change in steering angle can allow TRX-4M avoid snags or high-centering.
- Although unlikely, it is possible for radio interference to momentarily affect the performance of your model. If you notice erratic behavior from the steering or throttle, consider moving away from the source before continuing.
- Use good, common sense whenever you are driving your model. Intentionally driving in an abusive and rough manner will only result in poor performance and broken parts. Take care of your model so that you can enjoy it for a long time to come.
- It is possible for the screws and other hardware on your vehicle to loosen over time. Frequently check wheel nuts and other screws to ensure that all hardware remains properly tightened.

About Run Time

TRX-4M's small size and efficient drivetrain allow it to run for a long time on a single battery charge. The LiPo battery included with your model features a large 750mAh capacity for extended run times. Your run times may vary depending on surface conditions and driving style. Driving the vehicle on high-resistance surfaces like thick carpet or in tall grass will reduce run times. Applying full throttle and braking with every maneuver will also shorten run times. Consider smoother, more gradual throttle application for improved battery life.

Tips for Increasing Run Time

- ONLY use the supplied Traxxas iD® LiPo balance charger to charge the included Traxxas iD® battery.
- Read and follow all maintenance and care instructions.
- Keep the ECM-2.5 electronic control module clean and free of debris.
- Maintain your model. Do not allow dirt, debris, or damaged parts to cause binding in the drivetrain.

RUNNING IN WET CONDITIONS

Your TRX-4M is designed with water-resistant features to protect the electronics in the model (ECM-2.5 electronic control module, steering servo). This gives you the freedom to have fun driving your model through puddles, wet grass, snow, and through other wet conditions. Though highly water resistant, your model should not be treated as though it is submersible or totally 100% waterproof. Water resistance applies only to the installed electronic components. Running in wet conditions requires additional care and maintenance for the mechanical and electrical components to prevent corrosion of metal parts and maintain their proper function.

Precautions

- **Without proper care, some parts of your model can be seriously damaged due to contact with water. Know that additional maintenance procedures will be required after running in wet conditions in order to maintain the performance of your model. Do not run your model in wet conditions if you are not willing to accept the additional care and maintenance responsibilities.**



- The transmitter is not water resistant. Do not subject it to wet conditions, such as rain.
- Do not operate your model during a rain storm or other inclement weather where lightning may be present.
- Do not allow your model to come in contact with saltwater (ocean water), brackish water (between fresh water and ocean water), or other contaminated water. Saltwater is highly conductive and highly corrosive. Use caution if you plan to run your model on or near a beach.
- Even casual water contact can reduce the life of your motor. Special care must be taken to modify your driving style in wet conditions to extend the life of the motor (details below).

Before Running Your Vehicle in Wet Conditions

Consult the section “After Running Your Vehicle in Wet Conditions” before proceeding. Make sure you understand the additional maintenance required with wet running.

Motor Precaution

Avoid running your vehicle in water deep enough to submerge the Titan® 180 87T motor as it can reduce motor life. If the motor does get excessively wet or submerged, use very light throttle (run the motor slowly) until the excess water can run out. Applying full throttle to a motor full of water can cause premature motor failure. Your driving habits will determine motor life with a wet motor.

After Running Your Vehicle in Wet Conditions

1. Remove the battery.
2. Rinse excess dirt and mud off the truck with low-pressure water, such as from a garden hose. Do not use a pressure washer or other high-pressure water. Avoid directing water into the bushings, bearings, transmission, etc.

3. Blow off the truck with compressed air (optional, but recommended). Wear safety glasses when using compressed air.
4. Remove the wheels/tires from the truck.
5. Your vehicle comes equipped with low maintenance self-lubricating bushings, but it’s still good practice to spray all bushings, bearings, and other metal parts with WD- 40® or similar water-displacing light oil.
6. Let the truck stand or you may blow off with compressed air. Placing the truck in a warm, sunny spot will aid drying. Trapped water and oil will continue to drip from the truck for a few hours. Place it on a towel or piece of cardboard to protect the surface underneath.
7. **Additional Maintenance:** Increase your frequency of disassembly, inspection, and lubrication of the following items. This is necessary after extended wet use or if the vehicle will not be used for an extended period of time (such as a week or longer). This additional maintenance is needed to prevent any trapped moisture from corroding internal steel components.
 - **Front and rear axle assemblies:** Remove and clean the front and rear axles as needed. Refer to your exploded view diagrams for help with disassembly and reassembly.
 - **Transmission:** Remove, disassemble, and clean the transmission components. Refer to your exploded view diagrams for help with disassembly and reassembly.

TUNING ADJUSTMENTS



Important: The shocks are assembled at the factory with a center-to-center distance (between the rod end balls) of 51mm. Any time the shocks are removed and disassembled, this distance should be checked to ensure proper operation of the suspension.

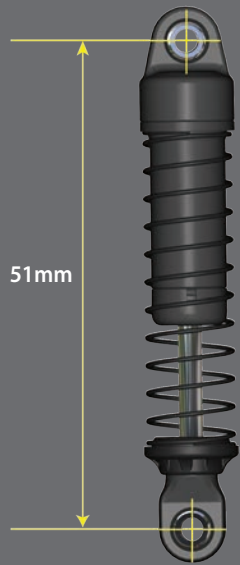

SUSPENSION TUNING

Springs

TRX-4M's front and rear springs (0.95 rate) have been carefully selected to provide full suspension articulation and support for the weight of the vehicle body. Using different bodies with lighter weight will allow you to use lower rate springs to increase suspension articulation when traversing difficult terrain.

SHOCK TUNING

Shock Oil

The 4 oil-filled shocks (dampers) effectively control the suspension movement by preventing the wheels and tires from continuing to "bounce" after rebounding from a bump. Changing the oil in the shocks can vary the suspension damping effect. Changing the oil to a higher viscosity oil will increase damping. Lowering the viscosity of the oil will cause the suspension damping to be reduced.

Damping should be increased (with higher viscosity oil) when stiffer springs are installed. Damping should be decreased (with thinner viscosity oil) when softer springs are installed. The viscosity of shock oil is affected by extremes in operating temperature; an oil of certain viscosity will become less viscous at higher temperatures and more viscous at lower temperatures. Operating in regions with cold temperatures may require lower viscosity oil. From the factory, the shocks are filled with SAE-20W silicone oil. Only use 100% silicone oil in the shock.

Replacing Shock Oil

The shocks have to be removed from the vehicle and disassembled to change the oil.

1. Remove the shock cap, bladder, and lower spring retainer.
2. Compress the shock fully so that the rod end is against the bottom of the shock body (A).
3. Fill the shock with new silicone shock oil to the top of the shaft; then, add 2-3 drops of oil to reach the proper level (B).

Note: Traxxas offers SAE-20W silicone shock oil as part #5031 or a full silicone shock oil set as part #5038X.

4. Move the piston up and down slowly to remove excess air. Add oil if needed to maintain the proper level.
5. Fully extend the shaft and reinstall the bladder, shock cap, and lower spring retainer.
6. Tighten the shock cap until snug.

Shock Disassembly

The shocks must be removed from the vehicle prior to disassembly. Use the shock exploded views included with the model to aid in the assembly process.

1. Remove the lower spring retainer and spring from the shock.
2. Remove the shock cap and empty the shock body of shock oil.
3. Use side cutters to grip the shock shaft just above the rod end. Remove the rod end from the shock shaft.
4. Remove the lower cap from the shock body with a small flat blade screwdriver. Slide the shock shaft with piston out of the shock body.
5. Remove the o-rings and spacer from the bottom of the shock body.

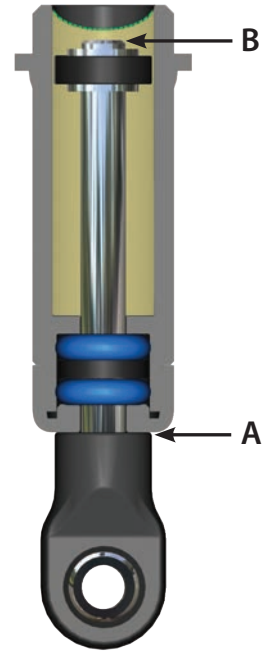

Shock Assembly

1. Insert the shock shaft assembly through the shock body until the piston bottoms out.
2. Lubricate the shaft and o-rings with silicone oil.
3. Install the one o-ring over the shaft and into the bore of the shock body followed by one small black spacer, and then another o-ring.
4. Install the lower cap by pressing it onto the shock body until it snaps on.
5. Grip the shaft close to the threads with needle nose pliers or side cutters and thread the rod end onto the shock shaft until the rod end bottoms out.
6. Fill the shock with new silicone shock oil (see the *"Replacing Shock Oil"* section on the previous page).
7. Slowly thread the upper cap with the installed shock bladder onto the shock body. The excess oil will bleed out of the small hole in the shock cap. Tighten the shock cap until snug.
8. Reinstall the spring and lower retainer.

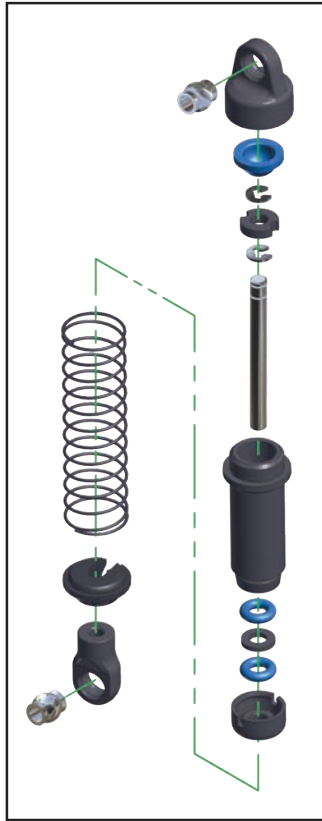

MAINTAINING YOUR MODEL



Always wear eye protection when using compressed air or spray cleaners and lubricants.

Your model requires timely maintenance in order to stay in top running condition. **The following procedures should be taken very seriously.**

Inspect the vehicle for obvious damage or wear. Look for:

1. Cracked, bent, or damaged parts
2. Check the wheels and steering for binding.
3. Check the operation of the shocks.
4. Check the wiring for any frayed wires or loose connections.
5. Check the mounting of the electronic control module (ECM) and servo.
6. Check the tightness of the wheel nuts with a wrench.
7. Check the operation of the radio system, especially the condition of the batteries.
8. Check for any loose screws in the chassis structure or suspension.

Other periodic maintenance:

- **Chassis:** Keep the chassis clean of accumulated dirt and grime. Periodically inspect the chassis for damage.
- **Shocks:** Keep the oil level in the shocks full. Use only 100% pure silicone shock oil to prolong the life of the seals. If you are experiencing leakage around the top of the shock, inspect the bladder for signs of damage or distortion from overtightening. If the bottom of the shock is leaking, then it is time for a rebuild. The Traxxas rebuild kits for two shocks are part #9762 and 9762A.
- **Suspension:** Periodically inspect the model for signs of damage, such as bent linkage rods, bent shock shafts, loose screws, or any signs of stress or bending. Replace components as needed.

- **Center Driveline:** Inspect the driveline for signs of wear such as worn or dirty center drive shafts, and any unusual noise or binding. Do not allow dirt and grime to collect in the drive cups. Tighten, clean, or replace components as needed.
- **Transmission:** Periodically remove the transmission from the model and inspect for any signs of damage. Disassemble and clean the transmission components. Replace components as needed. Complete Pro-Built® transmission assemblies are available as part #9791, 9791R, or 9791X.
- **Front and Rear Axles:** Remove and clean the front and rear axles as needed. Replace any damaged components.

Storage

When you are through running the model for the day, blow it off with compressed air or use a soft bristled paint brush to dust-off the vehicle. Always disconnect and remove the battery from the model whenever the model is stored. If the model will be stored for a long time, then also remove the batteries from the transmitter.

If you have questions or need technical assistance, call Traxxas at

1-888-TRAXXAS

(1-888-872-9927) (U.S. residents only)



TRX4^M



BRONCO

OWNER'S MANUAL

MODEL 97074-1

TRAXXAS

6250 TRAXXAS WAY MCKINNEY, TEXAS 75070

1-888-TRAXXAS



Ford Motor Company Trademarks
and Trade Dress used under
license to Traxxas.