



## Pro Scale® Advanced Lighting Control System Installation Instructions - 2021 Ford® Bronco®

Covers Part #9290

The Traxxas Pro Scale® Advanced Lighting Control System for your 2021 Ford Bronco consists of two major electronic components: the Pro Scale Lighting Power Module and the Pro Scale Lighting Distribution Block.

The Lighting Power Module installs on the chassis and performs as the voltage regulator and power supply for the lighting system. It also controls various lighting functions through the two buttons on the face of the module and communicates with the receiver in the model via the included MAXX® Link cable.

The Lighting Distribution Block mounts in the body of the vehicle and is the distribution hub for all the various wired lights in your Bronco body. Its main function is to direct power and instructions to the brake lights, reverse lights, turn signals, and high/low beam lighting.

There is only one rugged breakaway wiring connector between the Lighting Distribution Block and the Lighting Power Module for reliable lighting performance, plus it makes it easy to remove the body for vehicle service. The connector is designed to break away from the vehicle, without damage, if the body comes off the vehicle in a crash. There are lighting channels on the Lighting Power Module which allow the lighting installed on the chassis to be permanently connected and integrated into the system. This is helpful to install features such as rock lights, bumper lights, and other chassis-mounted accessory lighting.



### CAUTION: RISK OF DAMAGE TO BATTERIES!

Always disconnect the battery from the ESC when not in use to prevent the possibility of over-discharge and battery damage.

#### Kit Contents:

- Pro Scale Lighting Power Module
- Power module chassis mount
- Pro Scale Lighting Distribution Block
- Distribution block mount
- Motor sense wire harness
- Breakaway cable (part of the distribution block)
- MAXX® Link cable (Data Link) (TQi Radio System only)
- Front lights wiring harness
- Rear lights wiring harness
- Brake light LED decal
- 2.6x8mm button-head cap screw (4)
- 2.5x10mm countersunk cap screw (1)

- 2.5x12mm cap screw (1)
- 2.5x18mm cap screw (1)
- Zip ties (9)
- Silicone grease

#### Tools required:

- 1.5mm hex wrench (part #3415, sold separately)
- 2.0mm hex wrench (part #3415, sold separately)
- Wire cutters (to trim zip ties)
- Small needle nose pliers

### LIGHTING DISTRIBUTION BLOCK

Daytime Running Light Connectors

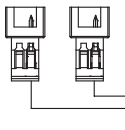

Wiring connectors for the lights are labeled with letters and/or colors.

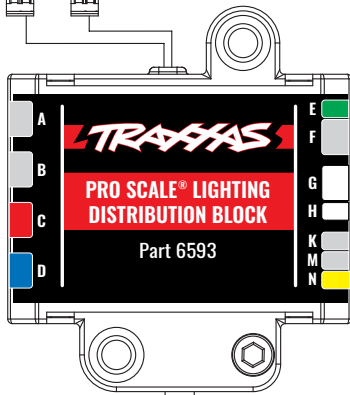

### LIGHTING POWER MODULE

to Traxxas XL-5 HV Electronic Speed Control (ESC) or direct battery power source up to 3s LiPo or 12.6V

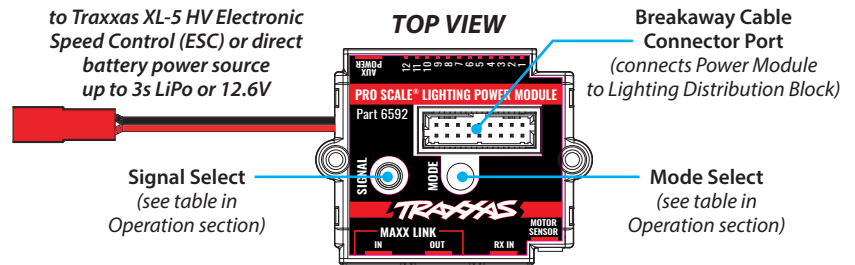

MAXX® Link Cable Ports (connects power module to receiver using MAXX Link cable) (TQi Radio System only)



### COMMUNICATION CABLE

Use the included MAXX® Link Cable to connect the Lighting Power Module to the receiver.

The MAXX Link Cable is designed to work with the Traxxas Link™ Wireless Module (part #6511, sold separately) to provide Traxxas Link App functionality for custom lighting controls and configurations. Some models may require a software update for the TQi receiver via the Traxxas Link App (Traxxas Link Wireless Module required).



## A. INSTALL THE LIGHTING POWER MODULE ON THE CHASSIS

1. Install the Power Module mount on the chassis with the included 2.5x10mm countersunk cap screw (Fig. 1).
2. Install the Lighting Power Module on the mount with the included 2.5x12mm (1) and 2.5x18mm (1) cap screws (Fig. 1).
3. Route the module power wire under the mount. Plug the red male connector from the ESC into the red female connector from the power wire (refer to the Chassis Wiring Diagram on page 3 for more detail).

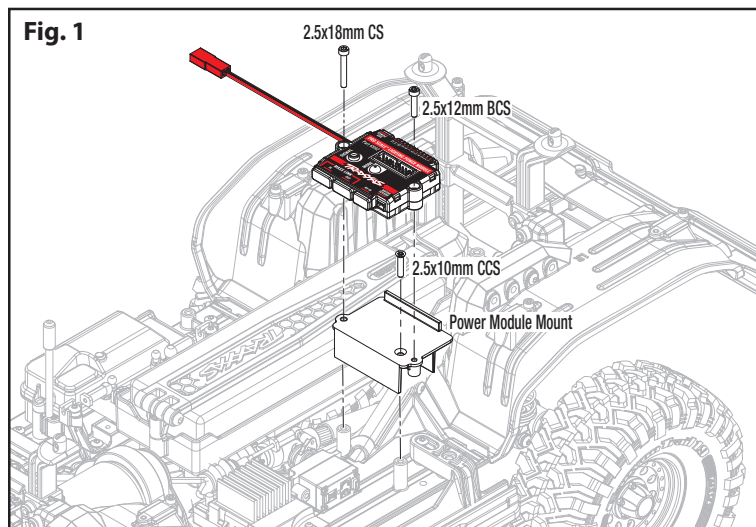

## B. WIRE THE LIGHTING POWER MODULE TO THE RECEIVER

1. Plug one end of the included MAXX<sup>™</sup> Link Cable into the MAXX Link IN port on the Power Module (Fig. 2) (refer to the Chassis Wiring Diagram on page 3 for more detail).
2. Remove the 3x10mm counter-sunk cap screws (2) from the battery tray (Fig. 3).
3. Lift up the battery tray and route the MAXX Link Cable from the Power Module under the battery tray and to the receiver box (refer to the Chassis Wiring Diagram on page 3 for more detail). Use a zip tie (included) to attach the wires to the loop on top of the transmission housing. Reinstall and tighten the battery tray screws. **Note: Be careful not to pinch or damage any of the wires under the battery tray.**

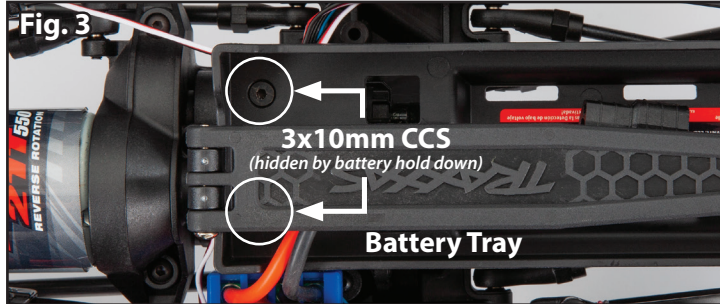

4. Remove the receiver box cover by removing the three 3x8mm button-head cap screws (Fig. 4).
5. Remove the wire clamp by removing the two 2.5x8mm cap screws (Fig. 4).
6. Feed the loose end of the MAXX Link Cable connector over the wire guide and into the receiver box. To make installation easier, unplug and remove a few of

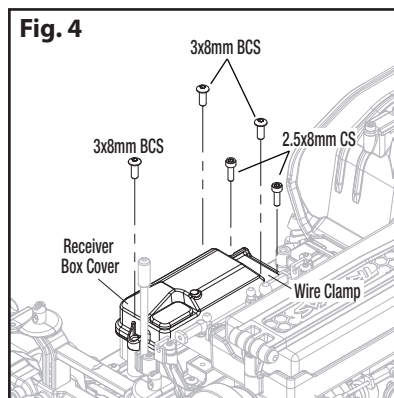

the existing wires from the receiver box. **Note the locations of any unplugged wires.** Use needle nose pliers to help grab the connector and pull it through. Arrange all wires neatly between the wire guides in the receiver box (Fig. 5). The excess wire will be bundled inside the receiver box.



7. Apply a bead of the included silicone grease to the wire clamp (Fig. 6).
8. Be careful not to damage the wires (make sure the wires are in the wire guides). Reinstall the wire clamp. Tighten the two 2.5x8mm cap screws securely (Fig. 7).
9. Plug the loose end of the cable into the expansion port on the receiver (Fig. 8).

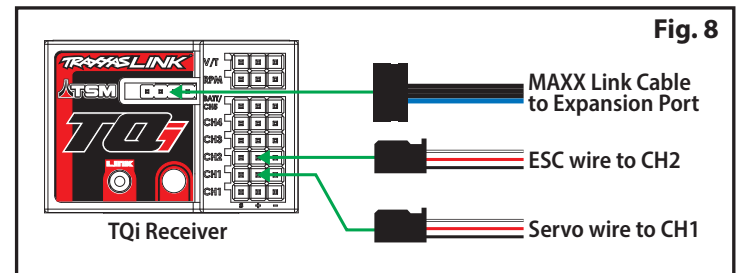
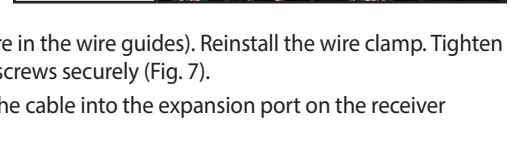
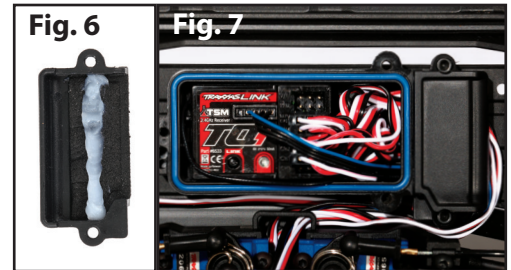

10. Make sure the blue O-ring seal is properly seated in the groove in the receiver box so that the cover will not pinch it or damage it in any way.
11. Reinstall the cover on the receiver box and tighten the three 3x8mm button-head cap screws securely. Inspect the cover to make sure that the O-ring seal is not visible.
12. Use the supplied zip ties to bundle the wires neatly and attach them to the vehicle as needed so that loose wires will not become entangled with moving parts.

## C. INSTALL THE MOTOR SENSE WIRING HARNESS

1. Unplug the red and black motor wires (bullet connectors) from the ESC. Plug the bullet connectors from the motor and the ESC into the motor sense wiring harness (red to red and black to black) (Fig. 9). Plug the harness connector into the Motor Sensor port on the power module (refer to the Chassis Wiring Diagram on page 3 for more detail).
2. Use the supplied zip ties to bundle the wires neatly and attach them to the vehicle as needed so that loose wires will not become entangled with moving parts.

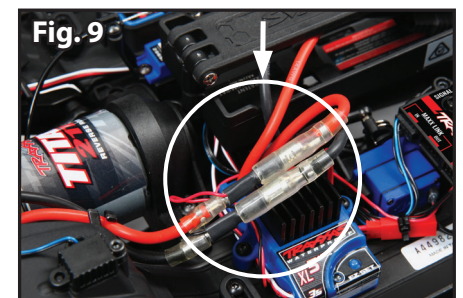

# CHASSIS WIRING DIAGRAM

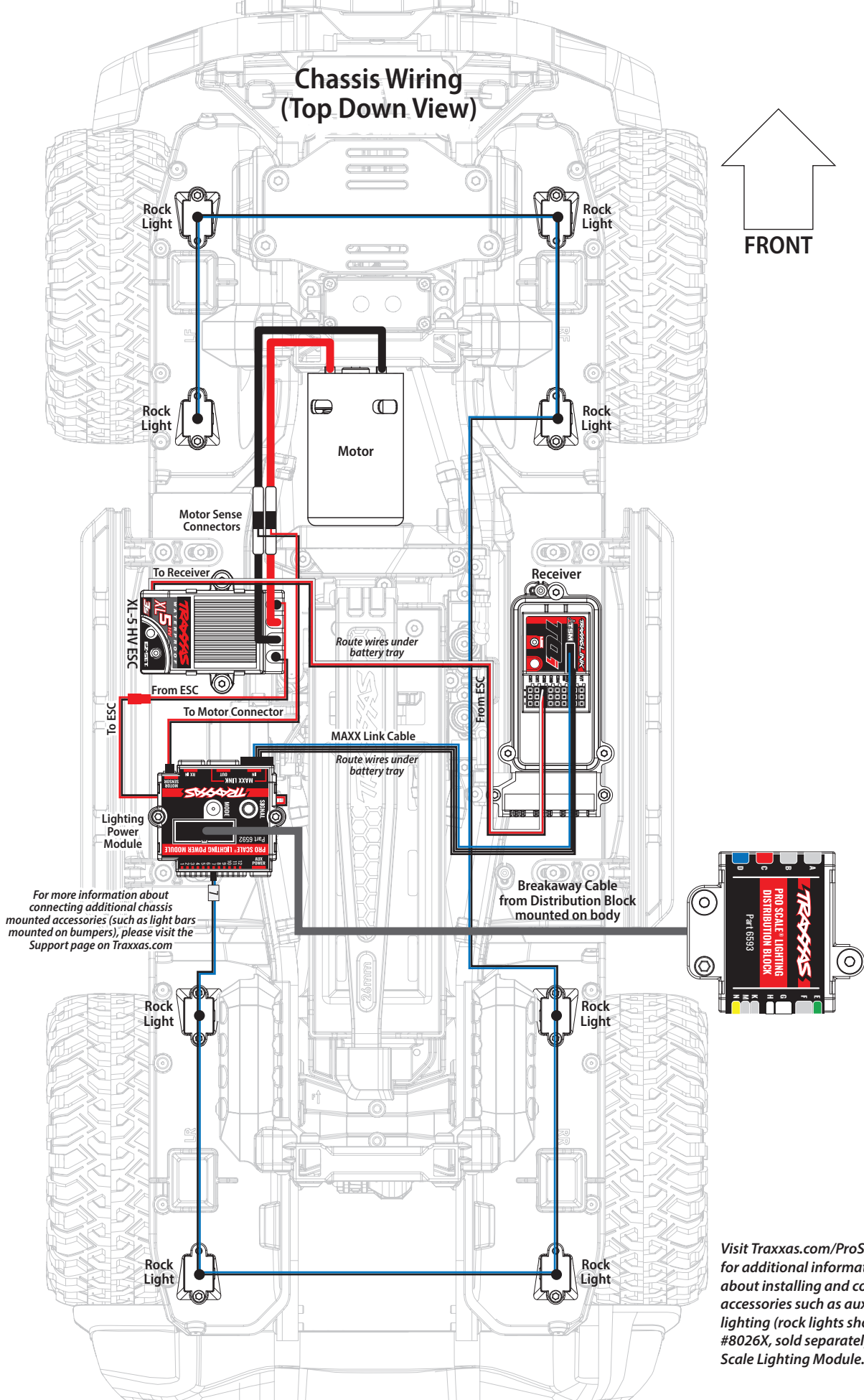

## D. INSTALL THE FRONT LIGHTS WIRING HARNESS

1. Remove the 2.6x8mm BCS (6) and 3x8mm BCS (4) to remove the front grille, grille mount, and front light assemblies from the body (Fig. 10).
2. Remove the 1.6x7mm BCS (2) and 2.6x8mm BCS (1) from each front light assembly (Fig. 10).
3. Remove the spacers and replace with the circuit boards of the included front lights harness (Fig. 10).
4. Reinstall all parts in reverse order.
5. Route the wiring harnesses in the body (*refer to the Body Wiring Diagram on page 5 for more detail*). Use the included zip ties to secure the wiring to the body in the locations indicated. The zip ties do not need to be tight; allow some extra length for wire movement. Use wire cutters to trim zip ties.

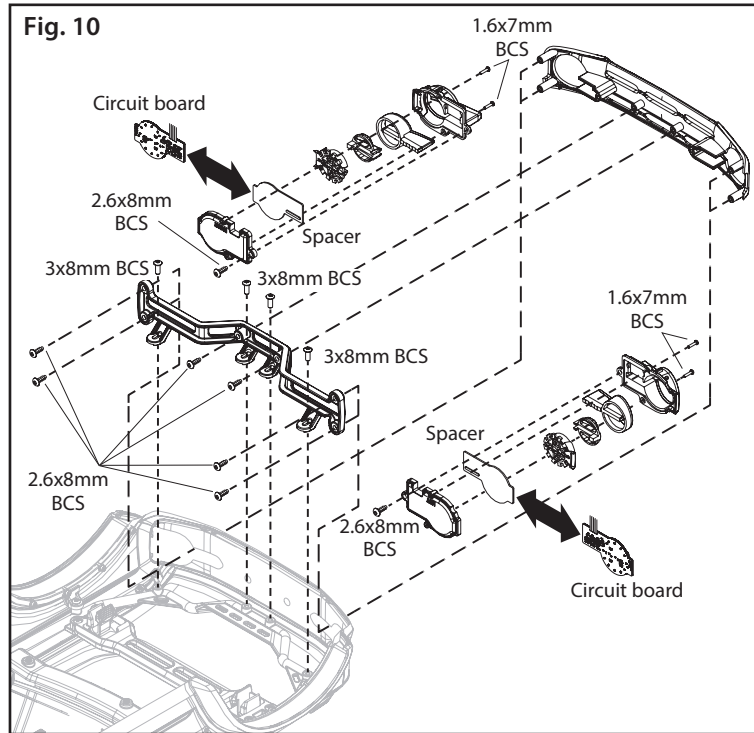

## E. INSTALL THE REAR LIGHTS WIRING HARNESS

1. Remove the 3x8mm BCS (4) to remove the rear light assemblies (Fig. 11).
2. Remove the 1.6x5mm BCS (2) from each rear light assembly (Fig. 11).
3. Apply the enclosed decals to the left and right LED brake light pipes. Align the decals with the back edge of the light pipes as shown in Fig. 11.
4. Remove the spacers from the light assemblies and replace with the circuit boards of the included rear lights harness (Fig. 11).
5. Reinstall all parts in reverse order.
6. Route the wiring harnesses in the body (*refer to the Body Wiring Diagram on page 5 for more detail*). Use the included zip ties to secure the wiring to the body in the locations indicated. The zip ties do not need to be tight; allow some extra length for wire movement. Use wire cutters to trim the zip ties.

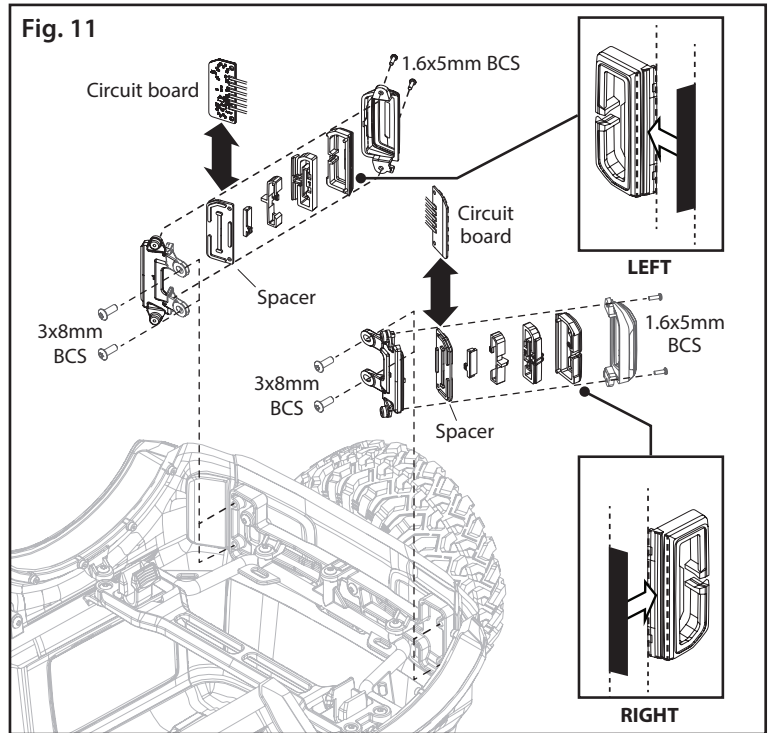

## F. INSTALL THE LIGHTING DISTRIBUTION BLOCK

1. Plug all LED light wire harness connectors into the ports on the Pro Scale distribution block. Match the color band and/or letter indicator on the wire harnesses with the corresponding color/letter of each port on the distribution block (*refer to the Lighting Distribution Block port chart below for more detail*).
2. Plug the white male daytime running light connectors from the front and rear lights wiring harnesses into the white female daytime running light connectors from the distribution block (*refer to the Body Wiring Diagram on page 5 for more detail*). **Note:** The daytime running lights will turn on when the battery is connected.
3. Install the distribution block mount and secure with the included 2.6x8 mm button-head screws (2) (Fig. 12).
4. Use the remaining 2.6x8mm button-head screws (2) to secure the distribution block to the mount (Fig. 12).
5. Plug the breakaway cable from the distribution block into the connector on top of the Power Module before installing the vehicle body (Fig. 13).

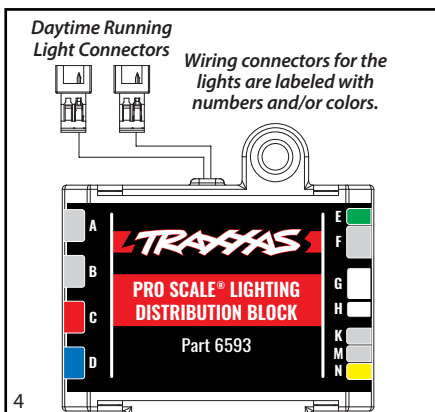
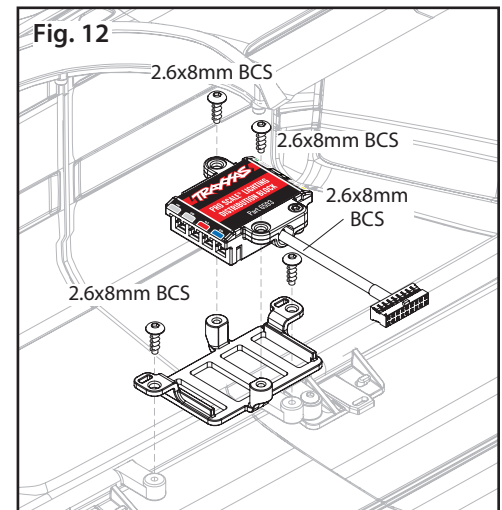

### LIGHTING DISTRIBUTION BLOCK LED LIGHT HARNESS PORTS

Letter	Color	Description	Function
A	N/A	Reverse light harness	Back up light LEDs when vehicle is put in reverse
B	N/A	Rear turn signal harness	Rear turn signal LEDs
C	Red	Tail light harness	Tail lights, brake lights, and rear integrated turn signal LEDs
G	White	Headlight assembly harness	Headlights and front marker light LEDs
H	White	Front turn signal harness	Front turn signal light LEDs
K	N/A	Rear high brake light harness	High brake light LEDs
N/A	N/A	Daytime running light connectors	Daytime running light LEDs

# BODY WIRING DIAGRAM

## Body Wiring (viewed from the underside of the body)

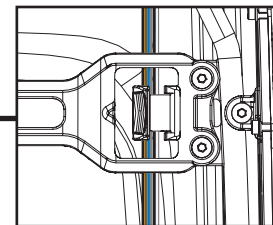
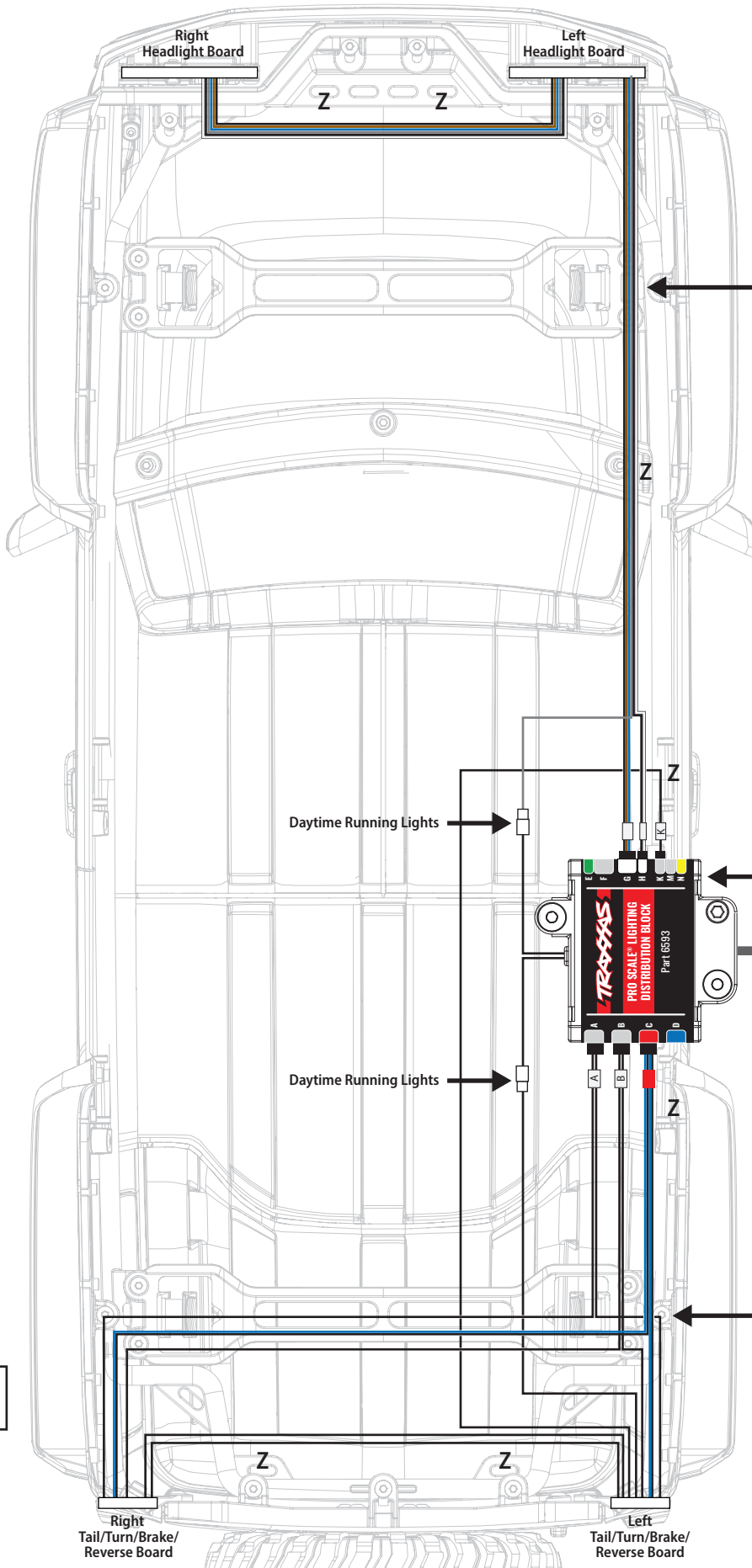

Route the wires above the clipless latch to avoid damage.

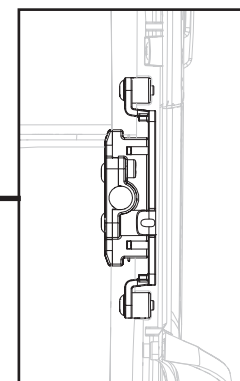

Actual mounting view. Distribution Block face shown in the diagram for clarity.

Breakaway Cable to Lighting Power Module on chassis

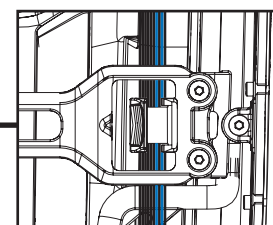
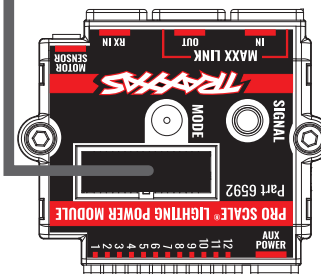

Route the wires above the clipless latch to avoid damage.

Z = Zip-tie Locations

# LIGHTING CONTROL SYSTEM OPERATION

## HEADLIGHTS MODE SELECTION

Use the **Mode** button on the Pro Scale Lighting Power Module to cycle through the different lighting modes (from **Low Beam Mode** to **High Beam Mode** to **Daytime Mode**).

## HAZARD LIGHTS

Use the **Signal** button on the Pro Scale Lighting Power Module to turn the hazard lights on or off.

## TURN SIGNALS

The turn signals are activated by default. To deactivate the turn signals, press and release the **Signal** button on the Pro Scale Lighting Power Module two times quickly. Both left turn signal LEDs will blink once, and then both right turn signals LEDs will blink once to indicate that the turn signals are deactivated.

**To reactivate the turn signals:** Press and release the **Signal** button two times again quickly. Both left turn signal LEDs will blink twice, and then both right turn signals LEDs will blink twice to indicate that the turn signals are activated.

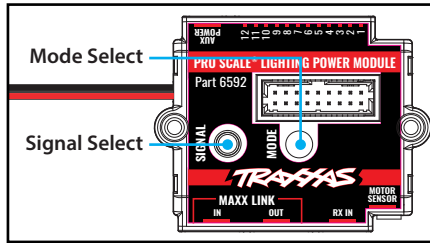

Mode	Selection	Action
	Low Beam Headlights	Default
	High Beam Headlights	Press and release <b>Mode</b>
	Daytime Headlights (off)	Press and release <b>Mode</b> once again

Signal	Selection	Action
	Hazard Lights On	Press and release <b>Signal</b> once
	Hazard Lights Off	Press and release <b>Signal</b> once again
	Deactivate Turn Signals	Press and release <b>Signal</b> 2x quickly
	Activate Turn Signals	Press and release <b>Signal</b> 2x quickly again

## TURN SIGNAL OPERATION

With the vehicle stopped, turn the steering wheel on the transmitter (left or right) to turn on the LEDs. The turn signal LEDs will continue to flash while the steering wheel is turned in this same direction or remains centered. Turn the steering wheel in the opposite direction to cancel the turn signal.

# APPENDIX

## MAXX LINK CABLE WIRING

Use the included **MAXX® Link Cable** to connect the Lighting Power Module to the receiver.

The MAXX Link Cable is designed to work with the Traxxas Link™ Wireless Module (part #6511, sold separately) to provide Traxxas Link App functionality for custom lighting controls and configurations.

Your model may require a software update for the TQi receiver via the Traxxas Link App (Traxxas Link Wireless Module required).



Traxxas Link Wireless Module (part #6511, sold separately)

## WIRING DIAGRAM WITH HIGH-OUTPUT EXTERNAL BEC (part #2262, sold separately)

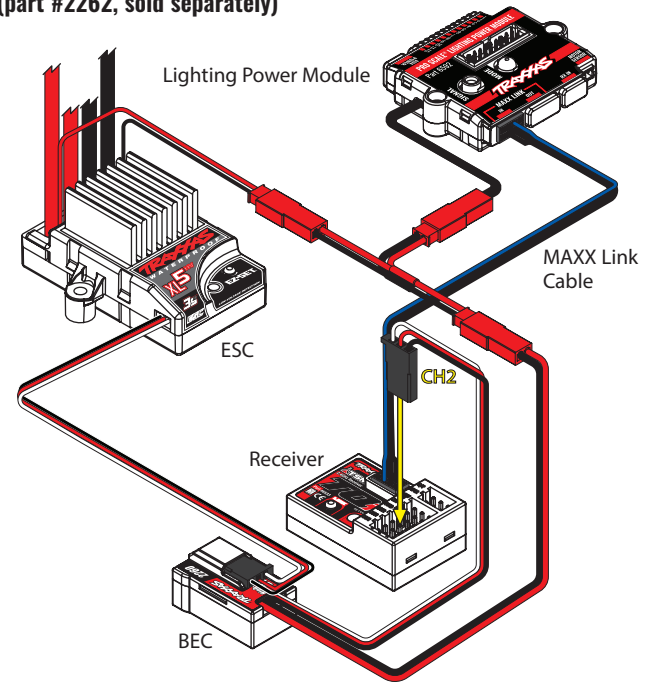

# WARRANTY

### Warranty Information

Traxxas electronic components are warranted to be free from defects in materials and workmanship for a period of 30 days from the date of purchase.

**Limitations:** Any and all warranty coverage does not cover replacement of parts and components damaged by abuse, neglect, improper or unreasonable use, crash damage, water or excessive moisture, chemical damage, improper or infrequent maintenance, accident, unauthorized alteration or modification or items that are considered consumable. Traxxas will not pay for the cost of shipping or transportation of a defective component to us.

### Traxxas Lifetime Electronics Warranty

After the expiration date of the warranty period, Traxxas will repair electronic components for a flat rate. Please visit [Traxxas.com/support](http://Traxxas.com/support) for a current schedule of warranty costs and fees. The covered repairs are limited to non-mechanical components that have NOT been subjected to abuse, misuse, or neglect. Products damaged by intentional abuse, misuse, or neglect may be subject to additional charges. Traxxas liability, in no case, shall be greater



than the actual purchase price of this product. For replacement, product must be returned in brand new condition, with packaging and itemized sales receipt.

Download and install the latest firmware updates, change the module settings, and gain access to additional functions using the Traxxas Link App (available in the Apple App Store<sup>SM</sup> or on Google Play<sup>TM</sup>). The TQi transmitter with the Traxxas Link Wireless Module (part #6511, sold separately) are required.



This device complies with FCC Part 15 & IC RSS-210 rules subject to the following conditions: 1) This device may not cause harmful interference, and 2) This device must accept all interference received, including interference that may cause undesired operation.

### For patent and patent-pending information, please visit [Traxxas.com/pat](http://Traxxas.com/pat)

App Store is a service mark of Apple Inc. Google Play is a trademark of Google Inc. Ford<sup>®</sup> and Bronco<sup>®</sup> are trademarks of Ford Motor Company. All copyrights and trademarks are used by Traxxas under license.